



# LSCD-6SR-30W-5CCT

6" Wattage Tuning & Selectable 5CCT Canless Square Reflector Commercial Downlight

LUMENS: 1800/2400/2700lm COLOR TEMPERATURE: 27K/30K/35K/40K/50K

APERTURE: Square

**Description** 6" LED commercial-grade high lumen downlight includes two tunable switches; selectable Lumens allows the end user to determine the wattage input and selectable 5CCT allows changing the color temperature appearance. With two tension steel spring clips, the 6" LED commercial-grade downlight can be installed without any frame-in or housing.

## FEATURES

- Wattage tuning between 18W/24W/30W
- Selectable 5CCT from 2700K/3000K/3500K/4000K/5000K
- Can-less installation (No housing is required)
- Optional Emergency back-up
- Field adjustable 24°-60° beam angle
- 120-277V, Triac and 0-10V dimming
- Available in Silver Reflector with White Flange
- 5 years warranty
- cETLus rated for Wet Locations



Wattage Tunable Switch



5CCT Selectable Switch



Twist lens to change beam angle output



**EM-15W**  
Optional Emergency Battery Backup

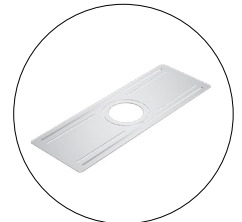

**LSCD-468-PL**  
Optional 4"/6"/8" Installation Plate

## PRODUCT IMAGES & DIMENSIONS



**LSCD-6RR-30W-5CCT-SWH**

6" Square Silver Reflector, White Flange Finish

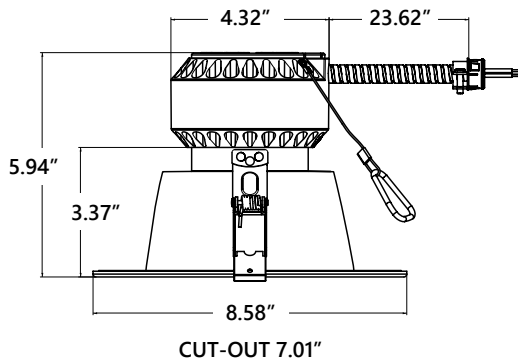

## SPECIFICATIONS

PART NUMBER	SIZE	WATTAGE TUNING	SELECTABLE 5CCT	CRI	VOLTAGE	DIMMING	FINISH	LISTING
<b>LSCD-6SR-30W-5CCT-SWH</b>	6"	18W/24W/30W	27K/30K/35K/40K/50K	90+	120-277V	TRIAC/0-10V	Silver/White	cETLus