

LED High Bay Installation UFO HIGH BAY BLADE SERIES

WARNING!

READ CAREFULLY BEFORE INSTALLING FIXTURE. RETAIN THESE INSTRUCTIONS FOR FUTURE REFERENCE.

- TO AVOID ELECTRIC SHOCK OR COMPONENT DAMAGE DISCONNECT POWER BEFORE ATTEMPTING INSTALLATION OR SERVICING
- TO AVOID ELECTRIC SHOCK OR COMPONENT DAMAGE, DO NOT USE THE CCTSWITCH AND POWER RANGE SWITCH AFTER INSTALLATION.
- THIS PRODUCT MUST BE INSTALLED IN ACCORDANCE WITH THE NATIONAL ELECTRIC CODE (NEC) AND ALL APPLICABLE FEDERAL, STATE AND LOCAL ELECTRIC CODES AND SAFETY STANDARDS.
- USE CAUTION WHEN HANDLING THIS PRODUCT DURING OR AFTER OPERATION AS IT MAY BECOME HOT AND CAUSE BURNS. DISCONNECT PRODUCT AND ALLOW COOLING PRIOR TO SERVICING.
- ANY ALTERATION OR MODIFICATION OF THIS PRODUCT IS EXPRESSLY FORBIDDEN AS IT MAY CAUSE SERIOUS PERSONAL INJURY, DEATH, PROPERTY DAMAGE AND/OR PRODUCT MALFUNCTION.
- TO PREVENT PRODUCT MALFUNCTION AND/OR ELECTRICAL SHOCK THIS PRODUCT MUST BE PROPERLY GROUNDING.

Installation Methods: Hook Mount, Ceiling Mount, 1/2 " NPT Mount.

(Please choose the most suitable installation method for the purchased product as per your needs)

Hook Mount

① Screw the hook into the fixture. tighten and fix it(Figure1)

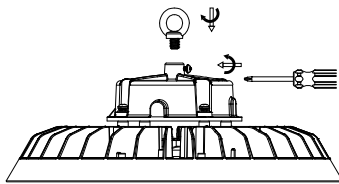

Figure 1

② Hang the fixture on the ceiling hook or chain(Figure2)

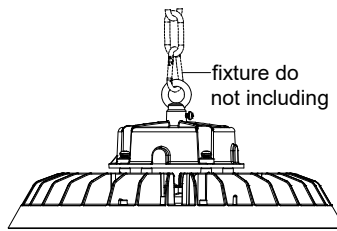

Figure 2

③ After installation,connect the wire of the fixture to the mains according to the local wiring rules,ensure the connection is stable And make good protection on the connection (Figure3)

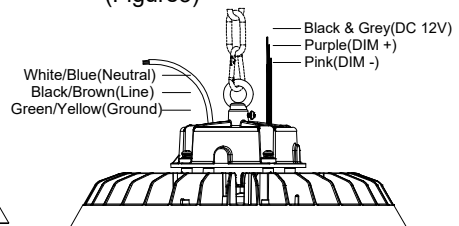

Figure 3

Ceiling Mount

① Install the bracket fixing base on the luminaire with screws (Figure4)

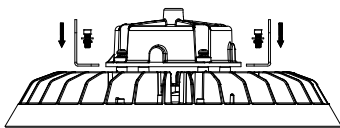

Figure 4

② Fasten the mounting bracket to the luminaire with screws (Figure5)

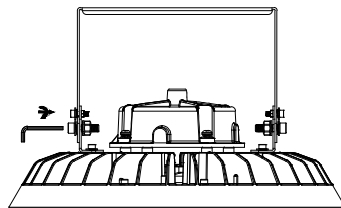

Figure 5

③ Open holes according to the above dimensions to install the explosive screws(Figure6)

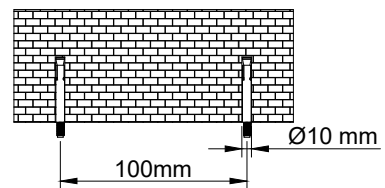

Figure 6

④ Fasten the mounting bracket with explosive screws (Figure 7)

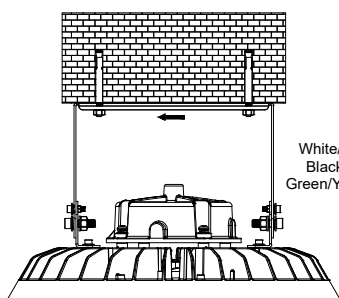

Figure 7

⑤ Turn off power, connect the wire as shown wiring diagram. (Figure 8)

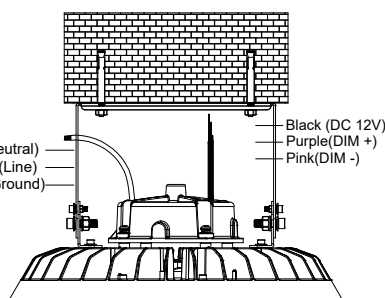

Figure 8

⑥ By adjusting the brackets screws,user can adjust 50° to the left or right vertically (Figure 9)

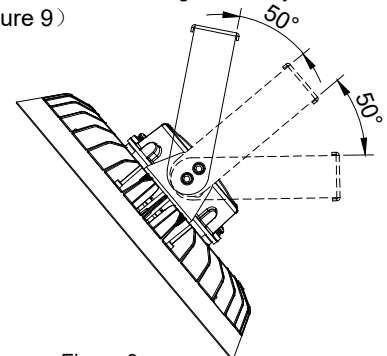

Figure 9

1/2"NPT Mount

- ① Unscrew the nuts on 1/2 "NTP.Insert 1/2"NTP stem into the bracket hole (Figure10)
- ② Re-screw the nuts(Figure11)
- ③ After installation, connect the wire of the fixture to the mains according to local wiring rules,ensure the connection is stable and make Good protection on connection.(Figure12)

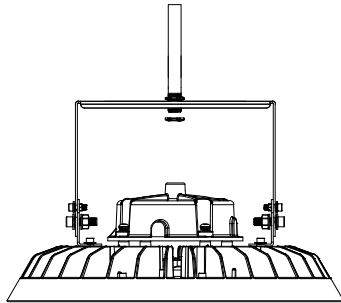

Figure 10

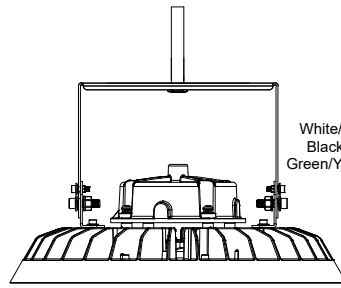

Figure 11

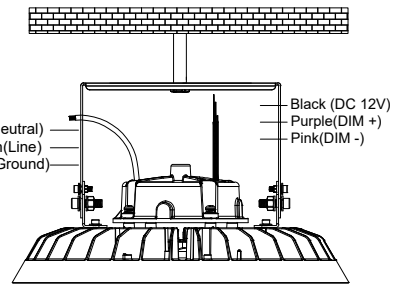

Figure 12

Installation of DC motion sensor:

- ① Screw the 1/2 " Knockout out with screw driver by illustrated direction, and screw the sensor kit on.(Figure13)

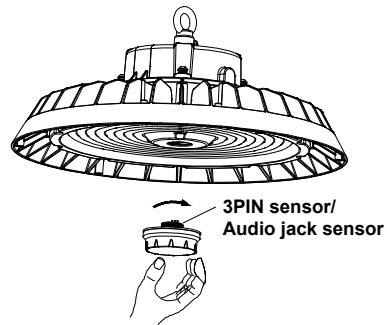
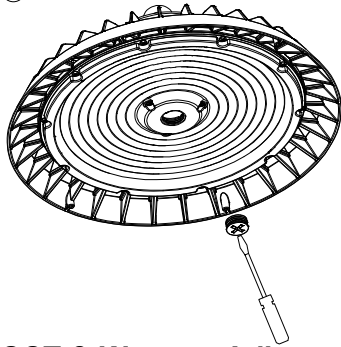

Figure 13

CCT & Wattage Adjustment

2 ways optional for CCT & Wattage Adjustment:
Wattage Adjustment Switch + CCT tunable switch

Interruptor Ajustable de CCT

Interruptor de Ajuste de Potencia

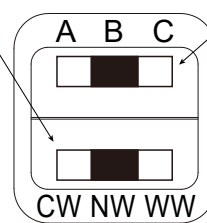
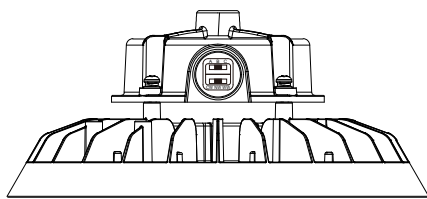

Wire guard installation

- ① Remove the screws from the UFO highbay,Install the wire guard / Aluminum Reflector /Polycarbonate Refractor /Polycarbonate Refractor Cover(Figure14 /Figure15/Figure16/Figure17)

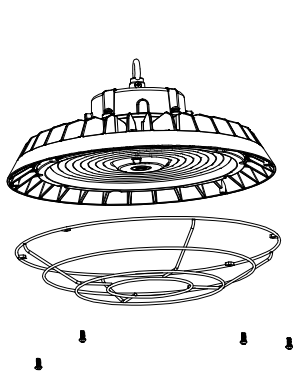

Figure 14

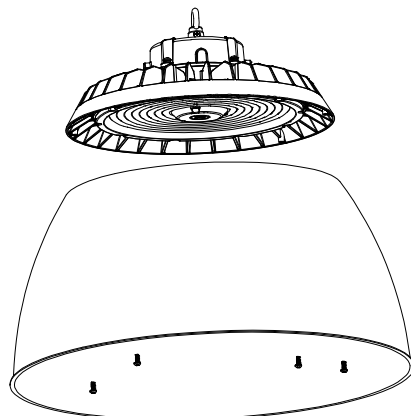

Figure 15

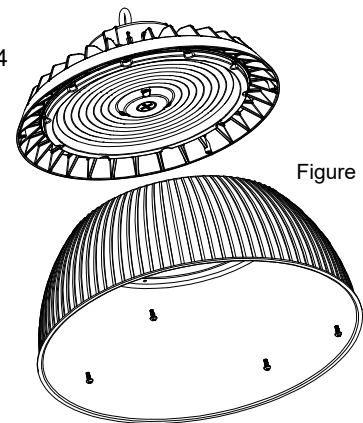

Figure 16

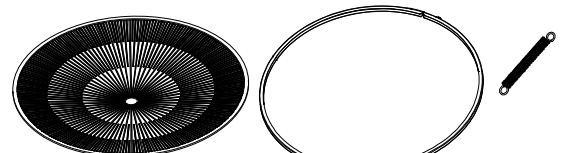

Figure 17